

Your success counts

## Flowcomputer with temperature compensation for corrected liquid volume



Modbus



Application examples: Salty Off-Shore conditions



Extreme cold weather at polar regions



Hot and sandy deserts

The E-Series provides unequalled safety and ease of use, opening the cover is history. The through-glass keypad enables operability without interruptions. The E-Series saves time, money and hassle and delivers user-friendliness in the toughest conditions.

### Advantages

- Save time and gain flexibility with the easy-to-operate through glass keypad: no need to remove the front cover or to arrange a work permit.
- Intuitive “Know one, know them all!” configuration menu, saving time, cost and aggravation.
- Cost saving with an easy to install, spacious chamber, plug and play connectors and 1” NPT thread for flow meter mounting.
- Durable high grade stainless steel 316L Ex d enclosure for extremely salty atmospheres (offshore).

### Features

- Explosion proof according ATEX, IECEx, FM and CSA c-us.
- Displays flow rate, total, acc. total, daily total, previous day total, actual line temperature, measuring units and a speedometer.
- Bright LED backlight.
- Easy K-factor configuration for volumetric or mass.
- Ability to process all types of signals: Sine wave (coil), NAMUR, NPN/PNP pulse, Reed-switch, Active pulse signals.
- Temperature: 2, 3 or 4-wire PT100 or (0)4 - 20mA input.
- Scaled pulse output according to compensate acc. total and input retransmission.
- Loop powered 4-20mA output acc. compensated flow rate.
- Modbus RS232 / RS485 or USB communication
- Power requirements: Loop powered, battery or 9 - 27V DC.
- Sensor supply: 8.2 / 12 / 24V DC.
- Auto backup of settings and running totals.
- Easy configurable via PC with free downloadable software.

## Introduction

The robust E126-EL is designed with a focus on your safety. It's beyond fulfilling the rules for hazardous area approvals, because the environment is often much tougher than explosion proof requirements demand. Experiencing flaws in your processes due to rain, snow, salty atmospheres (offshore) or early wear? The E126 delivers accurate measurement while withstanding the harshest conditions. The corrected volumetric flow is calculated by using the thermal expansion coefficient algorithm stored in the flowcomputer. The reference temperature can be defined as desired, e.g. 15°C, 20°C or 60°F. A typical application is flow calculation of water, fuel or chemicals at base conditions.

## Configuration

The E-Series uses the highly appreciated configuration structure of our F-, D- and N-Series product lines. Each setting is clearly indicated with an alphanumeric description, which avoids confusing abbreviations. Once familiar with one E-series product, you will be able to program all models in all series without a manual. For example: an (intrinsically safe) F126 is almost identical to an explosion proof E126 with the same three buttons: Know one, know them all!

## Operation

Operation is done via the optical, easy-to-operate, through glass keypad without having to remove the front cover. These optical keys can be disabled. For easy handheld configuration there are three mechanical push buttons on the bottom side of the display collar when the cover is removed. All settings are accessed via a simple operator menu that can be passcode protected.



## Display

The unique LCD display provides multiple flow data at a glance. The main information is displayed with 7 digits (12mm, 0.47") to show total, flow rate, and temperature. The display has 11 digits (7mm, 0.28"), which can be set to show flow rate and accumulated total. Current day total (daily total) and previous day total, both non resettable are available as well. The last 15 historical day totals are stored and can be displayed. On-screen engineering units are easily configured from a comprehensive selection, while different units for flow rate and total can be displayed simultaneously. The speedometer offers a quick impression of the corrected flow rate. For good readings in full sunlight and darkness, the E126 is provided with a bright backlight. When battery powered the backlight is only operational after a keypad touch, to save battery life.

## Hazardous areas

The E-Series has been certified according ATEX, IECEx, FM and CSA c-us with an ambient temperature of -40°C to +70°C (-40°F to +158°F). For stainless steel 40°C to +67°C (-40°F to +153°F).

- The ATEX markings for gas and dust applications are:
  - Ex II 2 G Ex db IIC T6 Gb.**
  - Ex II 2 D Ex tb IIIC T85°C Db.**
- The IECEx markings for gas and dust applications are:
  - Ex db IIC T6 Gb.**
  - Ex tb IIIC T85°C Db.**
- The FM and CSA c-us markings are:
  - XP (Explosion-proof): Class I, Division 1, Groups A, B, C, D.**
  - DIP (Dust-Ignition-proof): Class II/III, Div. 1, Groups E, F & G.**
  - Class I, Zone 1, AEx d IIC T6 Gb, Zone 21, AEx tb IIIC T85°C Db.**



All info at a glance



Easy to install



Easy to program



Know one know them all!



Reliable



User-friendly

### Analog output

The corrected flow rate is transmitted with the galvanically isolated 4 - 20mA output signal. The E126 can even be loop powered via the isolated loop-current.

### Pulse outputs

A scaled pulse output is available according the corrected accumulated total. The unscaled pulse output retransmits the incoming pulse signal. The pulse length is user defined from 1msec up to 10 seconds. The output can be a passive NPN signal or a mechanical relay output.

### Power requirements

Several power inputs are available to power the E126 and sensor. As standard, the E126 can be loop powered via the isolated, two-wire, analog output. The battery powered version with a long life lithium battery and the basic 9 - 27V DC can power the E126 including the backlight, but don't offer a real sensor supply. A real sensor supply of 8.2, 12 or 24V is optional available with type PD.

### Communication

Processed data can be read, total can be cleared and settings can be read and modified through the Modbus link (RS232 / RS485) or the local USB communication which is located at the side entry plug. Under safe conditions, the plug can be removed for easy configuration or data log extraction with a PC or laptop.

### Enclosures

Two versions of our IP66/IP67, NEMA Type4X/7/9 explosion proof enclosures are available: a solid die cast aluminum or a high grade stainless steel 316L enclosure resistant to extremely salty atmospheres (offshore). The aluminum enclosure has an industrial two component coating and is better suitable for outdoor and chemical plant applications than powder coated alternatives. A major advantage for the installation engineer is the spacious mid-chamber for the cable entry in combination with the plug-and-play connectors. Especially for straight flow meter mounting a 1" NPT connection is available (see page 5 for available NPT and Metric threads sizes).

### Remote configuration

Even more user-friendly is the remote configuration via a PC using the free downloadable E-Series Configuration Software. Depending on your product, just connect the E-Series to your PC with the special Configuration Cable (ACE02) or use the Modbus or USB communication cables (ACE01/06/07).

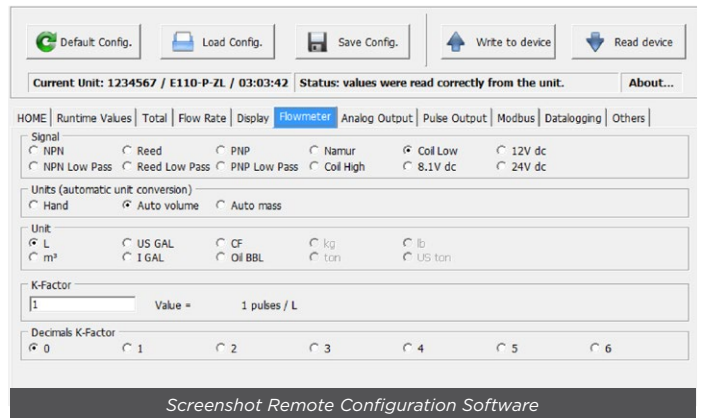

Easy-to-operate through glass keypad



High grade Stainless Steel 316L enclosure



USB communication

### Overview application E126-EL

Flow measurement in applications where nett flow calculation at base conditions is desired without the influence of thermal product expansion. The E126 offers you a flowcomputer designed to be used in rough and tough applications, beyond being just explosion proof. Its sturdy design and ease of use are unequaled by any other explosion proof flowcomputer in the market! The E-Series is always your first and safest choice in explosion proof applications. For intrinsically safe applications we offer our field mount F-Series flowcomputers.

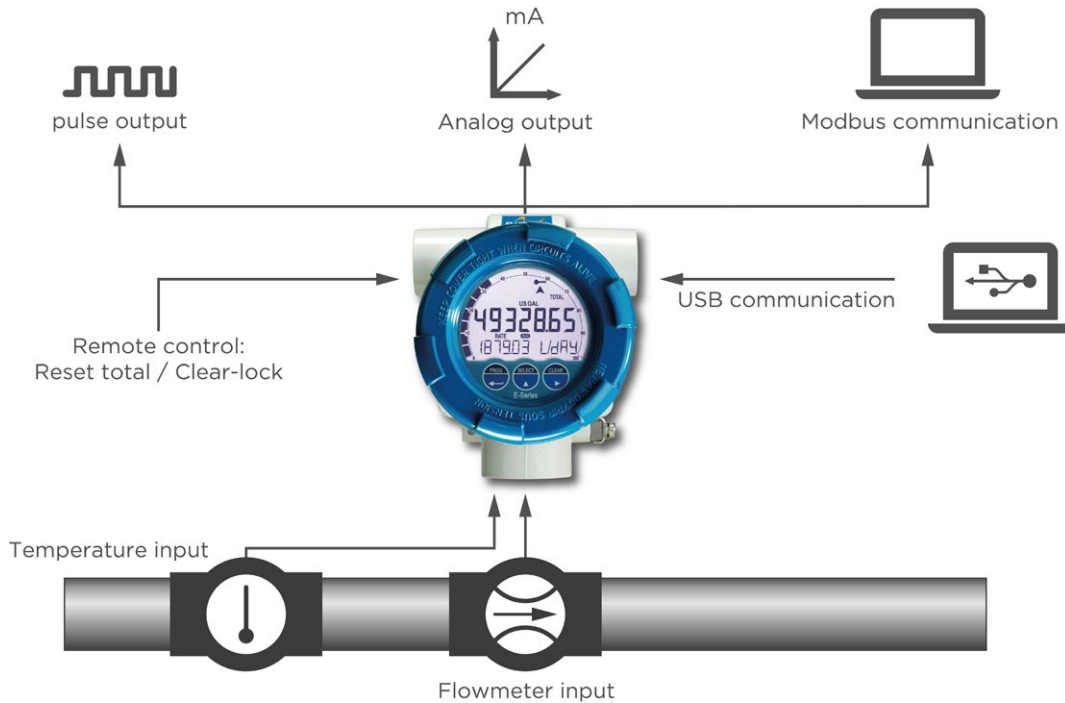

### Signal input

The E126-EL accepts most pulse input signals for flow. The input signal type can be selected in the configuration menu without having to adjust any sensitive mechanical dipswitches or jumpers. For the temperature measurement, 2, 3 or 4-wire PT100 elements or sensors with a (0)4 - 20mA output signal can be used.

Type of signal	Resistance	Low Pass filter (LP)	Max. frequency	Max. frequency Low Pass filter (LP)	Min. amplitude p-P	Remark
NPN	100kΩ pull-up	100kΩ pull-up	6kHz Threshold 1.2V	2.2kHz		Open collector
REED	1MΩ pull-up	1MΩ pull-up	1.2kHz Threshold 1.2V	120Hz		
PNP	51KΩ pull-down	51KΩ pull-down	6kHz Threshold 1.2V	700Hz		
NAMUR	820Ω pull-down	-	4kHz	-		External power required
COIL LO	-	-		-	90mV <sub>pp</sub>	Default sensitivity
COIL-HI					20mV <sub>pp</sub>	Sensitive for interference!
COIL-HI (Type ZF)	-	-	-	-	10mV <sub>pp</sub>	
COIL-HI (Type ZG)					5mV <sub>pp</sub>	
ACTIVE 8.2V DC	3K9Ω		10kHz Threshold 4V			External power required
ACTIVE 24V DC	3KΩ		10kHz Threshold 12V			External power required

## Dimensions enclosures

Aluminum & Stainless Steel 316L enclosure

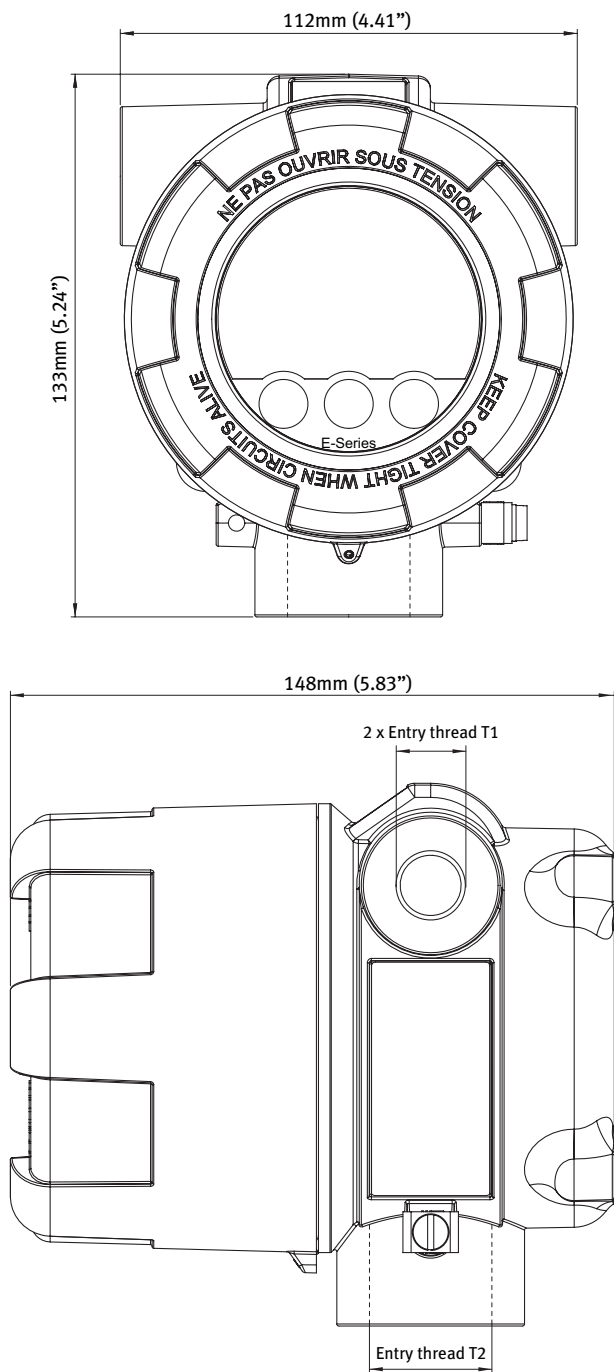

## Enclosure types

Type HA_	Aluminum Ex d enclosure.
Weight	1300 gr.
Type HS_	Stainless steel 316L Ex d enclosure.
Weight	3600 gr.

## Enclosure drillings

Type H_A	T1: 2 x 3/4"NPT / T2: 1 x 1"NPT
Type H_B	T1: 2 x 3/4"NPT / T2: 1 x 3/4"NPT
Type H_C	T1: 2 x 1/2"NPT / T2: 1 x 1"NPT
Type H_D	T1: 2 x 1/2"NPT / T2: 1 x 3/4"NPT
Type H_G	T1: 2 x M20 / T2: 1 x M25
Type H_H	T1: 2 x M25 / T2: 1x M25

## Terminal connections

### Main Electronics Module

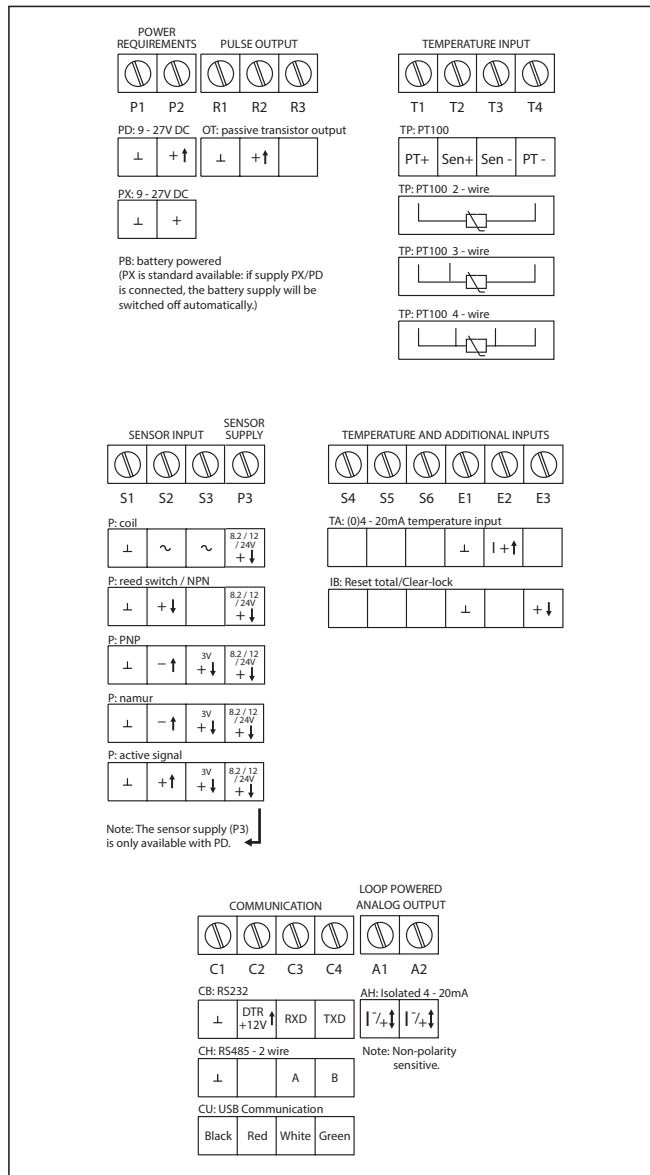

### Supply Module

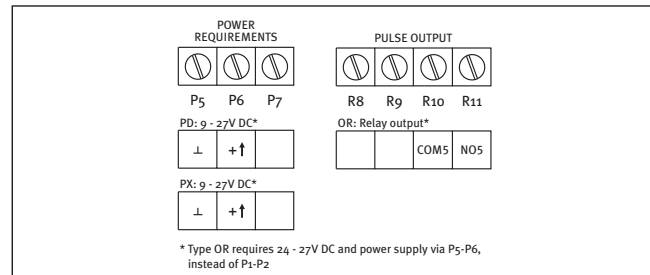

## E126-P-AH-CB-EL-IB-OR-PD-TA

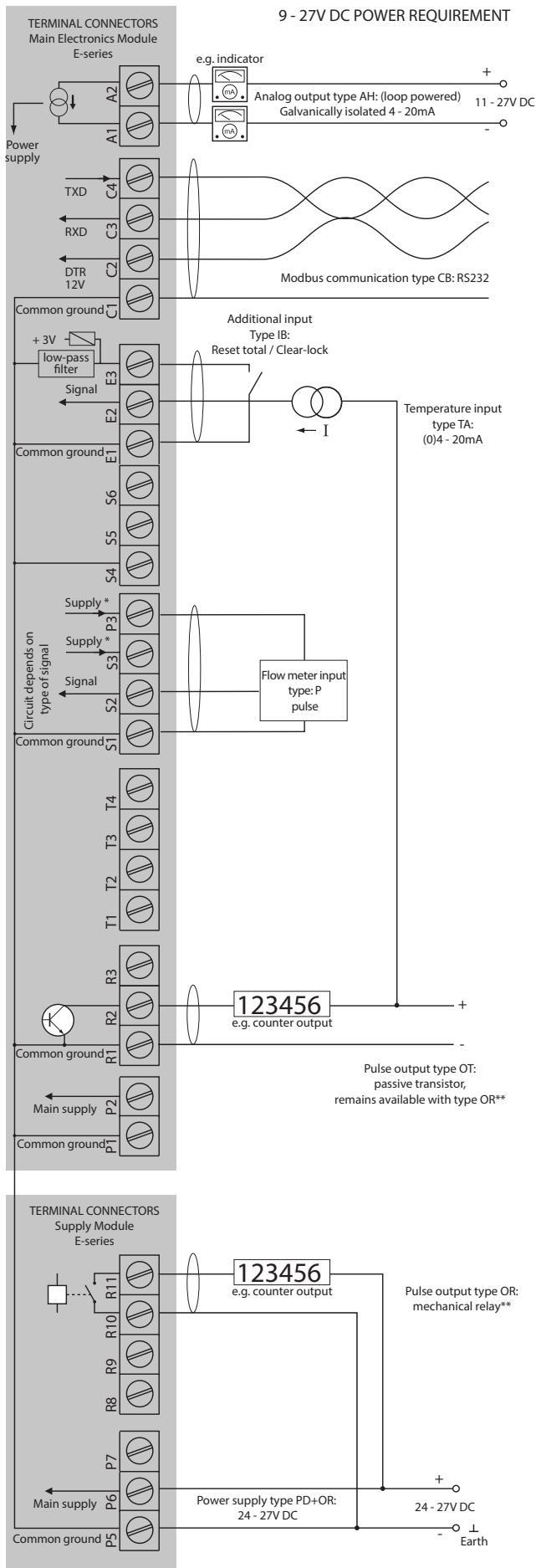

\* Supply voltage P3: 8.2 / 12 / 24V DC to sensor

\*\* Type OR requires 24 - 27V DC and power supplied via P5-P6, instead of P1-P2

## E126-P-AH-CH-EL-IB-OT-PX-TP

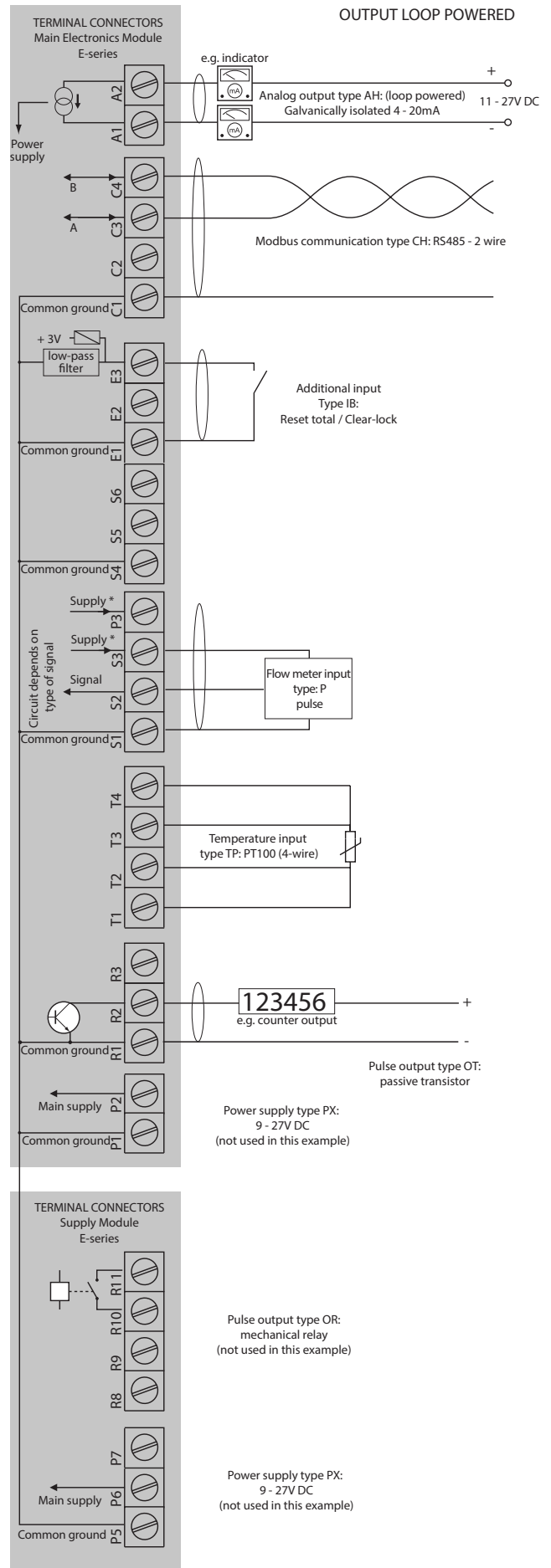

\* Supply voltage S3: 3V DC to sensor

## Display

<b>Type</b>	High intensity transfective numeric and alphanumeric LCD, UV-resistant, with bright backlight. Intensity can be adjusted via the keypad.
<b>Note</b>	When battery powered, the backlight is only operational after a keypad touch, to extend battery lifetime.
<b>Dimensions</b>	Ø 65 x 45mm (2.56" x 1.77").
<b>Digits</b>	Seven 12mm (0.47") and eleven 7mm (0.28") digits. Various symbols and measuring units.
<b>Refresh rate</b>	User definable: 8 times/sec. - 30 secs.
<b>Speedometer</b>	To indicate the actual flow rate the bargraph runs from 0 to 100% in 20 blocks, each block is 5%.

## Operating temperature

<b>Ambient HA_</b>	-40°C to +70°C (-40°F to +158°F).
<b>Ambient HS_</b>	-40°C to +67°C (-40°F to +153°F).

## Power requirements

<b>Type PB</b>	Long life Lithium battery - life-time depends upon settings and configuration - up to approx. 3 years.
<b>Note PB</b>	The battery can power the backlight for a short time after a keypad touch but cannot power the relay output (OR) or the real sensor supply (Terminal P3).
<b>Type PD</b>	9 - 27V DC. Consumption max. 4.5 Watt.
<b>Type PX</b>	9 - 27V DC. Consumption max. 3 Watt.
<b>Type AH</b>	Loop powered, analog output. 11 - 27V DC, Min. 3.5mA. Consumption max. 675mW (25mA @ 27VDC)
<b>Note AH</b>	The loop powered analog output cannot power the backlight, mechanical relay output (OR) or the real sensor supply (Terminal P3).

## Sensor excitation

<b>Type AH/PB/PX</b>	Terminal S3: 3V DC for pulse signals and 1.2V DC for coil pick-up, I <sub>out</sub> max. 100µA.
<b>Note AH/PB/PX</b>	This is not a real sensor supply. Only suitable for sensors with a very low power consumption like coils (sine wave) and reed-switches.
<b>Type PD</b>	Terminal P3: 8.2 / 12 / 24V DC 8.2V DC, I <sub>out</sub> max. 20mA. 12V DC, I <sub>out</sub> max. 30mA. 24V DC, I <sub>out</sub> max. 75mA (this voltage varies depending on the input supply voltage)

## Terminal connections

<b>Type</b>	Removable plug-in terminal strip. Wire max. 1.5mm <sup>2</sup> and 2.5mm <sup>2</sup> .
-------------	---

## Data protection

<b>Type</b>	EEPROM backup of all settings. Backup of running totals every minute. Data retention at least 10 years.
<b>Password</b>	Configuration settings and clear total can be password protected.

## Directives & Standards

<b>EMC</b>	Directive 2014/30/EU, FCC 47 CFR part 15.
<b>Low voltage</b>	Directive 2014/35/EU
<b>RoHS</b>	Directive 2011/65/EU
<b>ATEX / IECEx</b>	Directive 2014/34/EU, IEC 60079-0, IEC 60079-1, IEC 60079-31.
<b>FM</b>	Class 3600, 3615, 3616, 3810.
<b>CSA</b>	CSA 22.2 No. 25, No. 30, No. 61010-1-12.
<b>UL</b>	UL 61010-1.
<b>IP &amp; NEMA</b>	EN 60529 & NEMA 250.

## Hazardous area - Explosion proof

<b>ATEX certification</b>	Gas:  II 2 G Ex db IIC T6 Gb.
<b>IECEX certification</b>	Dust:  II 2 D Ex tb IIIC T85°C Db.
<b>IECEX certification</b>	Gas: Ex db IIC T6 Gb. Dust: Ex tb IIIC T85°C Db.
<b>FM &amp; CSA c-us certification</b>	Class I, Div. 1, Grps A, B, C, D. Class II/III, Div. 1, Grps E, F, & G. Class I, Zone 1, AEx d IIC T6 Gb, Zone 21, AEx tb IIIC T85°C Db.

## Enclosure - General

<b>Window</b>	Glass window.
<b>Sealing</b>	Silicone.
<b>Control keys</b>	Three infra-red keys with operation through the glass front window.
<b>Rating</b>	IP66, IP67 / NEMA Type4X / Type7 / Type9.
<b>Dimensions</b>	112 x 133 x 148mm (4.41" x 5.24" x 5.83") - W x H x D.

## Enclosure - Types

<b>Type HA_</b>	Aluminum Ex d enclosure.
<b>Weight</b>	1550 gr. (3.41 lbs).
<b>Type HS_</b>	Stainless steel 316L Ex d enclosure.
<b>Weight</b>	3600 gr. (9.65 lbs).

## Enclosure - Drillings

<b>Type H_A</b>	Entry threads: 2 x 3/4"NPT / 1 x 1"NPT
<b>Type H_B</b>	Entry threads: 3 x 3/4"NPT
<b>Type H_C</b>	Entry threads: 2 x 1/2"NPT / 1 x 1"NPT
<b>Type H_D</b>	Entry threads: 2 x 1/2"NPT / 1 x 3/4"NPT
<b>Type H_G</b>	Entry threads: 2 x M20 / 1 x M25
<b>Type H_H</b>	Entry threads: 3 x M25

## General E-Series accessories

<b>ACE01</b>	USB data logging and configuration cable for type CU.
<b>ACE02</b>	Remote configuration cable for type CX.
<b>ACE03</b>	Stainless steel wall mounting kit (inc. screws+plugs).
<b>ACE04</b>	Stainless steel pipe mounting kit.
<b>ACE05</b>	2 pins, 30cm (12") cable with Amphenol connector.
<b>ACE06</b>	Remote configuration cable (1.8m/5.9ft) for type CH.
<b>ACE07</b>	Remote configuration cable (1.8m/5.9ft) for type CB.

## Signal inputs - Flowmeter

<b>Type P</b>	Coil / sine wave (HI: 20mVpp or LO: 90mVpp - sensitivity selectable), NPN/PNP, reed switch, Namur, active pulse signals 8 or 24V DC.
<b>Frequency</b>	Minimum 0Hz - maximum 10kHz for total and flow rate. Maximum frequency depends on signal type and internal low-pass filter. E.g. reed switch with low-pass filter: max. frequency 120Hz.
<b>K-Factor</b>	0.000010 - 9,999,999 with variable dec. position.
<b>Low-pass filter</b>	Available for all pulse signals.
<b>Option ZF</b>	coil sensitivity 10mVpp.
<b>Option ZG</b>	coil sensitivity 5mVpp.

## Signal inputs - Temperature

<b>Type TA</b>	(0)4 - 20mA. Analog input signal can be scaled to any desired range within 0 - 20mA.
<b>Accuracy</b>	15 bit. Error 0.01% @ 20°C (Typical 35ppm/°C).
<b>Span</b>	0.00000 / 999,999 K with variable dec. position.
<b>Offset</b>	0.01 - 9,999.99 K.
<b>Update time</b>	One time per second.
<b>Voltage drop</b>	Max. 1V DC @ 20mA.
<b>Note TA</b>	External power to sensor is required; e.g. type PD.
<b>Type TP</b>	Range -100°C to +200°C (-148°F to 392°F).
<b>Wires</b>	2-, 3- or 4-wire PT100.
<b>Update time</b>	One time per second.
<b>Accuracy</b>	2-wire: +/- 0.1°C @ Ta 20°C + 0.008°/Ta °C. 3- or 4-wire: +/- 0.1°C @ Ta 20°C + 0.005°/Ta °C.

## Signal inputs - Additional input

<b>Function</b>	Terminal input to reset total remotely or to lock the "clear total" button.
<b>Type IB</b>	Internally pulled-up switch contact - NPN.
<b>Duration</b>	Minimum pulse duration 100msec.

## Signal outputs - Digital output

<b>Function</b>	<ul style="list-style-type: none"> <li>• Scaled pulse: Transmitting corrected acc total.</li> <li>• Input pulse retransmission (squared, OT only).</li> </ul>
<b>Frequency</b>	Max. 500Hz. Pulse length user definable between 1msec up to 10 seconds. Retransmission: Minimum pulse duration: 50µs, square wave.
<b>Type OR</b>	One isolated electro-mechanical relay output (NO). Max. resistive load: 1A @ 250V AC / 30V DC. Maximum inductive load: 0,5A (pilot duty applications). Type OT remains also available.
<b>Restrictions OR</b>	Requires 24 - 27V DC and supplied via P5 - P6. Frequency max. 0.5Hz.
<b>Type OT</b>	One passive transistor output (NPN) - not isolated. 300mA - 50V @ 25°C.

## Signal outputs - Communication option

<b>Function</b>	Reading display info, clear total and read/write configuration settings.
<b>Protocol</b>	Modbus ASCII / RTU.
<b>Type CB</b>	RS232
<b>Type CH</b>	RS485 2-wire
<b>Type CU</b>	Local USB communication for connection to a PC / laptop incl. Ex d USB plug at the right-hand side entry.
<b>Restriction CU</b>	Requires 3/4"NPT or M25 side entry thread.
<b>Type CX</b>	No communication, remote configuration possible with accessory cable ACE02.

## Signal outputs - Analog output

<b>Function</b>	Transmitting corrected flow rate.
<b>Type AH</b>	Galvanically isolated, loop powered 4 - 20mA output
<b>Accuracy</b>	12 bit. Error 0.03% @ 20°C (Typical 45ppm/°C). Output signal can be scaled to any desired range.

## Flow equations

<b>Type EL</b>	Corrected liquid volume.
<b>Formula</b>	$Q_{normal} = Q \times (1 + (\alpha_{ref} - T))$ where $\alpha$ = thermal expansion coefficient.
<b>Reference temp.</b>	Default: 288.15K (15°C / 59°F). Any temperature can be set.

## Operator functions

<b>Displayed info</b>	<ul style="list-style-type: none"> <li>• Compensated flow rate and / or total.</li> <li>• Compensated total and accumulated total.</li> <li>• Current day (daily) total and previous day</li> <li>• The last 15 historical day totals are stored and can be displayed.</li> <li>• Actual line temperature.</li> <li>• Indicating speedometer for flow rate.</li> <li>• Reset total by pressing the CLEAR-key twice.</li> </ul>
-----------------------	--

## Total

<b>Digits</b>	7 digits.
<b>Units</b>	L, m <sup>3</sup> , US gal, igal, cf, Oil bbl, kg, ton, US ton, lb or none.
<b>Decimals</b>	0 - 1 - 2 or 3.
<b>Note</b>	Total can be reset to zero.

## Accumulated total

<b>Digits</b>	11 digits.
<b>Units / decimals</b>	According to selection for total.
<b>Note</b>	Can not be reset to zero.

## Flow rate

<b>Digits</b>	7 digits.
<b>Units</b>	mL, L, m <sup>3</sup> , mg, g, kg, ton, US ton, US gal, igal, Oil bbl, lb, cf, rev, none, scf, nm <sup>3</sup> , nL or p.
<b>Decimals</b>	0 - 1 - 2 or 3.
<b>Time units</b>	/sec - /min - /hr - /day.

## Line temperature

<b>Digits</b>	6 digits.
<b>Units</b>	°C, °F or K
<b>Decimals</b>	1.



		Description
Model	<b>E126-EL</b>	<b>Flowcomputer with temperature compensation for corrected liquid volume.</b>
Input	<b>P</b>	<b>Pulse input: coil, npn, pnp, namur.</b>
Analog output	<b>AH</b>	<b>Galvan. isolated, loop powered 4-20mA output.</b>
Communication	CB	RS232 communication - Modbus ASCII / RTU.
	CH	RS485 communication - 2wire - Modbus ASCII / RTU.
	CU	USB communication - requires. 3/4"NPT or M25 thread.
	<b>CX</b>	<b>No communication, remote configuration is possible.</b>
Equation	<b>EL</b>	<b>Corrected liquid volume.</b>
Enclosures	<b>HA_</b>	<b>Die-cast aluminum Ex d enclosure.</b>
	HS_	Stainless steel 316L Ex d enclosure.
	<b>H_A</b>	<b>Entry threads: 2 x 3/4"NPT / 1 x 1"NPT.</b>
	H_B	Entry threads: 3 x 3/4"NPT.
	H_C	Entry threads: 2 x 1/2"NPT / 1 x 1"NPT.
	H_D	Entry threads: 2 x 1/2"NPT / 1 x 3/4"NPT.
	H_G	Entry threads: 2 x M20 / 1 x M25.
	H_H	Entry threads: 3 x M25.
Additional	<b>IB</b>	<b>Remote control input to reset total or to lock the "clear total" button.</b>
Digital output	OR	Mechanical relay output (OT remains available) - requires 24 - 27V DC.
	<b>OT</b>	<b>Passive transistor output.</b>
Power	PD	9 - 27V DC + sensor supply.
	<b>PX</b>	<b>Basic power supply 9 - 27V DC (no real sensor supply).</b>
Battery	PB	Additional lithium battery powered (optional).
Temp. input	TA	(O)4 - 20mA temperature input
	<b>TP</b>	<b>PT100 temperature input.</b>
Hazardous	<b>XD</b>	<b>Explosion proof according ATEX, IECEx, FM and CSA c-us.</b>
Options	<b>ZB</b>	<b>Backlight is included as standard.</b>
	ZF	Coil input 10mVpp.
	ZG	Coil input 5mVpp.

The **bold** marked text contains the standard configuration: E126-P-AH-CX-EL-HAA-IB-OT-PX-TP-XD-ZB.